



Audio Frequency General Purpose Amplifier Applications

**2SC4738**

**FEATURES**

- High voltage and high current.
- High  $h_{FE}$ .
- Complementary to 2SA1832.
- Small package.

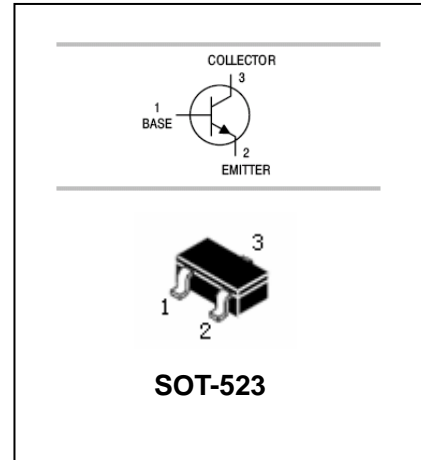

**ORDERING INFORMATION**

Type No.	Marking	Package Code
2SC4738	LY/LG/LB	SOT-523

**MAXIMUM RATING @  $T_a=25^\circ\text{C}$  unless otherwise specified**

Symbol	Parameter	Value	Units
$V_{CBO}$	Collector-Base Voltage	60	V
$V_{CEO}$	Collector-Emitter Voltage	50	V
$V_{EBO}$	Emitter-Base Voltage	5	V
$I_C$	Collector Current -Continuous	150	mA
$I_B$	Base Current	30	mA
$P_C$	Collector Power Dissipation	100	mW
$T_j, T_{stg}$	Junction and Storage Temperature	-55 to +125	$^\circ\text{C}$



Audio Frequency General Purpose Amplifier Applications

**2SC4738**

**ELECTRICAL CHARACTERISTICS @ Ta=25°C unless otherwise specified**

Parameter	Symbol	Test conditions	MIN	TYP	MAX	UNIT
Collector cut-off current	$I_{CBO}$	$V_{CB}=60V, I_E=0$			0.1	$\mu A$
Emitter cut-off current	$I_{EBO}$	$V_{EB}=5V, I_C=0$			0.1	$\mu A$
DC current gain	$h_{FE}$	$V_{CE}=6V, I_C=2mA$	120		700	
Collector-emitter saturation voltage	$V_{CE(sat)}$	$I_C=100mA, I_B=10mA$		0.1	0.25	V
Transition frequency	$f_T$	$V_{CE}=10V, I_C=1mA$	80			MHz
Collector output capacitance	$C_{ob}$	$V_{CB}=10V, I_E=0mA, f=1MHz$		2.0	3.5	pF

**CLASSIFICATION OF  $H_{FE}$**

RANK	Y	GR	BL
RANGE	120-240	200-400	350-700
MARKING	LY	LG	LB



TYPICAL CHARACTERISTICS

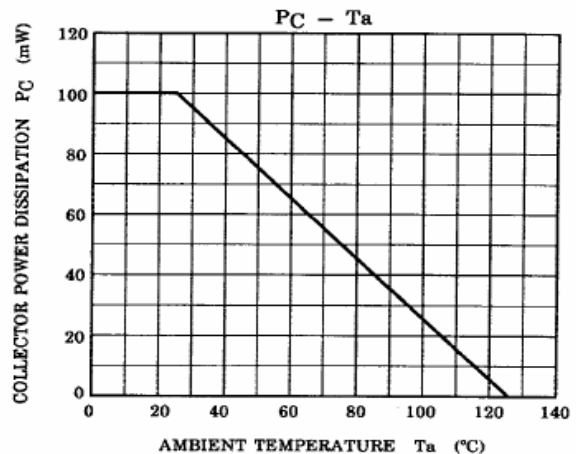
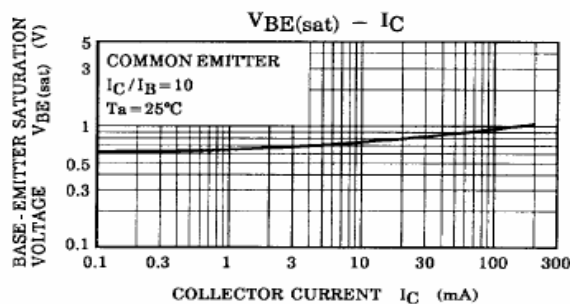
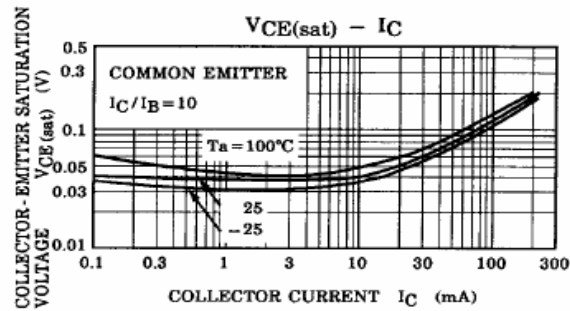
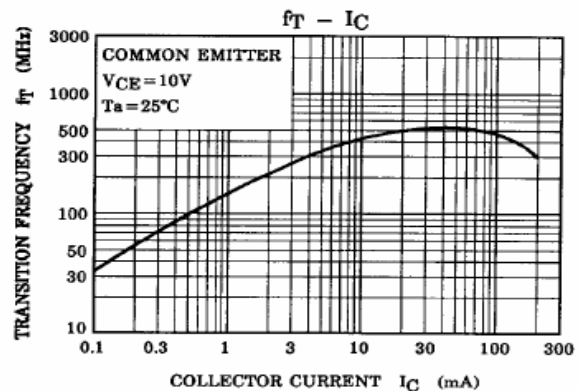
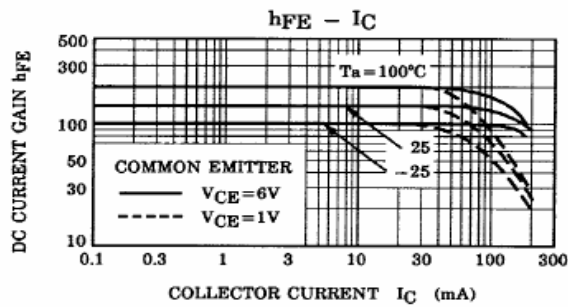
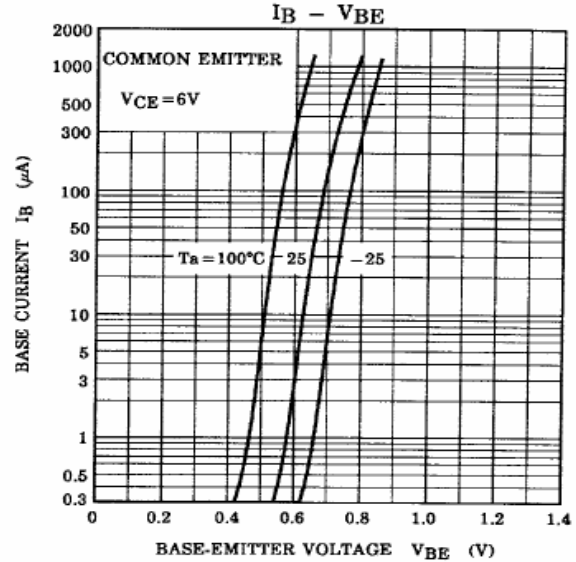
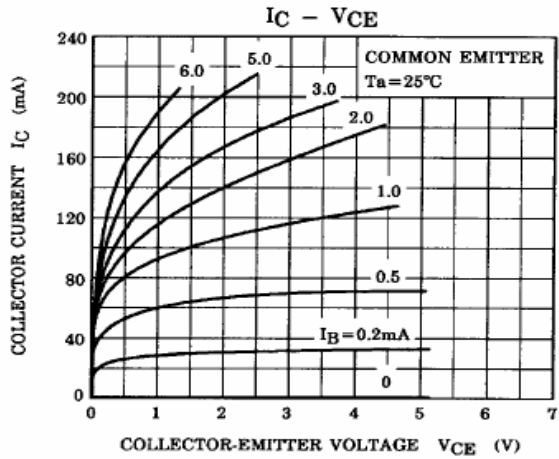



Audio Frequency General Purpose Amplifier Applications

**2SC4738**

**PACKAGE OUTLINE**

Plastic surface mounted package

SOT-523

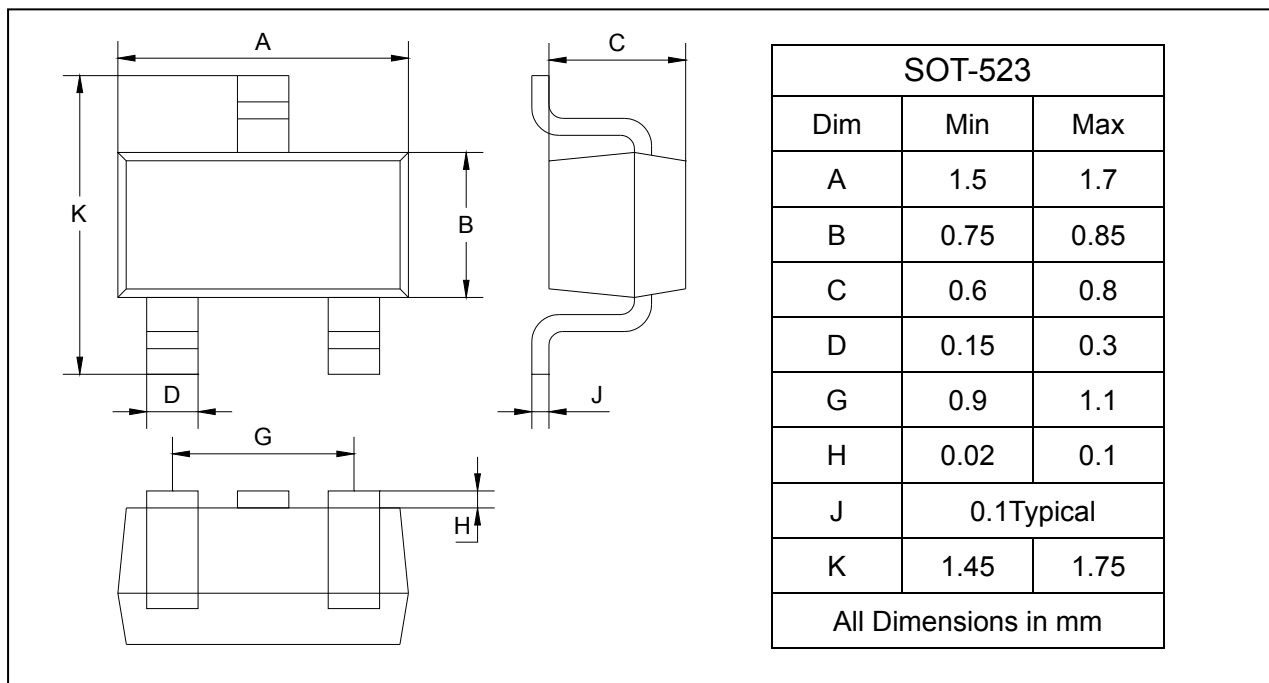

**SOLDERING FOOTPRINT**

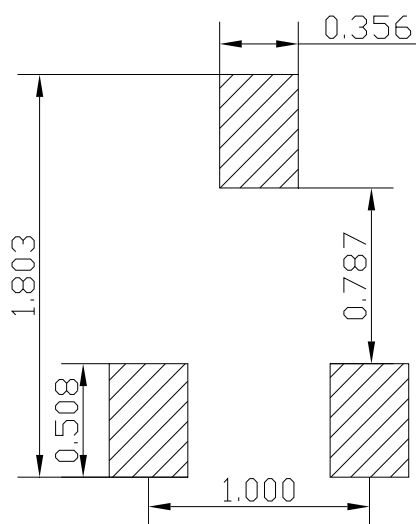

Unit : mm

**PACKAGE INFORMATION**

Device	Package	Shipping
2SC4738	SOT-523	3000/Tape&Reel